

Pozi ie	Cant.	Descriere
	1	<p>UPS2 25-80 180</p>  <p>Nr. Produs: 98707853</p> <p>High-efficiency circulator pump with permanent-magnet motor (ECM technology) fit for the ErP directive No 641/2009 due to continuously variable speed control for circulation of clean heating water according to VDI 2035.</p> <p>Features and benefits: UPS2 25-80 180</p> <p>High-efficiency circulator pump with permanent-magnet motor (ECM technology) complying with the ErP directive No 641/2009 thanks to continuously variable speed control. Suitable for circulation of clean heating water according to VDI 2035.</p> <p>Features and benefits:</p> <ul style="list-style-type: none"> • Complying with requirements of the ErP directive as from 2015. • 1 pump replaces 3 variants. • It is available as pump head without pump housing. Fits on all 4-m, 5-m and 6-m pump housings of the Series 100. • For tight installations, i.e. in boiler applications. • High energy savings thanks to an energy efficiency index (EEI) lower than 0.23. • Complies with the German regulation on energy saving in buildings and building systems – Energieeinsparverordnung – EnEV §14(3). • One button for simple selection among three proportional-pressure curves or three fixed speeds. • No corrosion issues thanks to the electrocoated pump housing. • Reduced installation costs as no external motor protection is required. <p>Liquid: Lichide pompatate: Ap Gama temperaturii lichidului: 2 .. 95 °C Liquid temperature during operation: 60 °C Densitate: 983.2 kg/m³</p> <p>Technical: Clasa TF: 95 Aprob ri pe etichet : CE</p> <p>Materials: Corpul pompei (stator): Font EN-JL1020 ASTM A48-25B Rotor: Compozit, PES/PP</p> <p>Instala ie: Presiune de func ionare maxim : 10 bar Racordarea pompei la instala ie: G 1 1/2 Presiune maxim de func ionare: PN 10 Distan a dintre porturi: 180 mm</p>



Date: 15.06.2018

Pozitie	Cant.	Descriere
		<p>Electrical data: Frecven a re elei electrice: 50 Hz Tensiune nominal : 1 x 230 V Grad de protec ie (IEC 34-5): X2D Clas de izolare (IEC 85): F</p>

98707853 UPS2 25-80 180 50 Hz

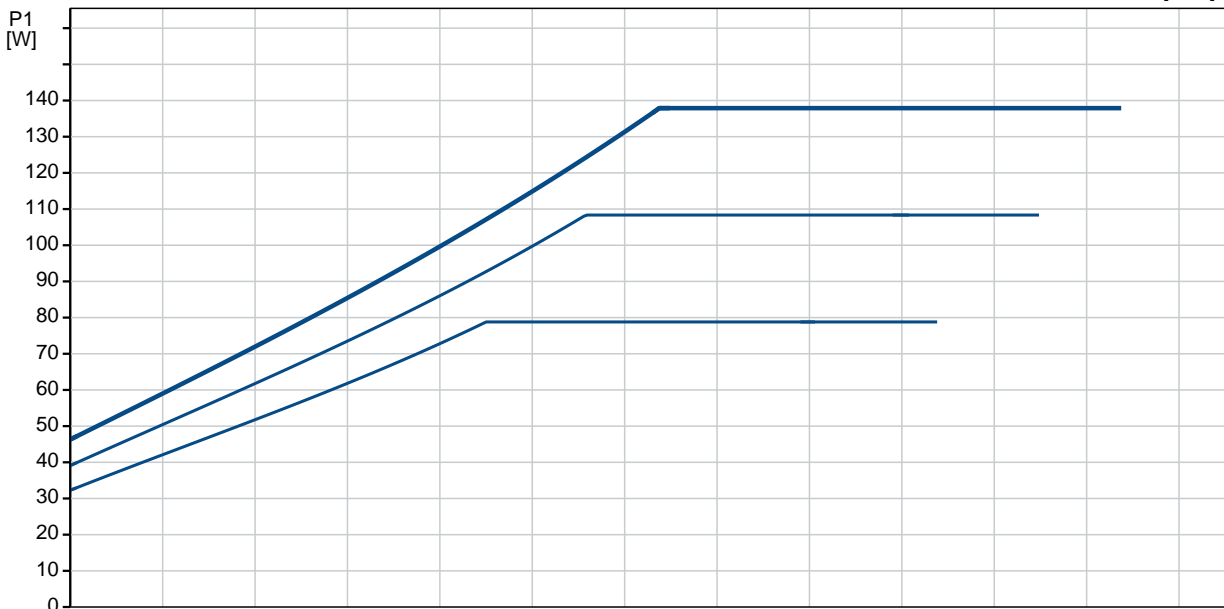
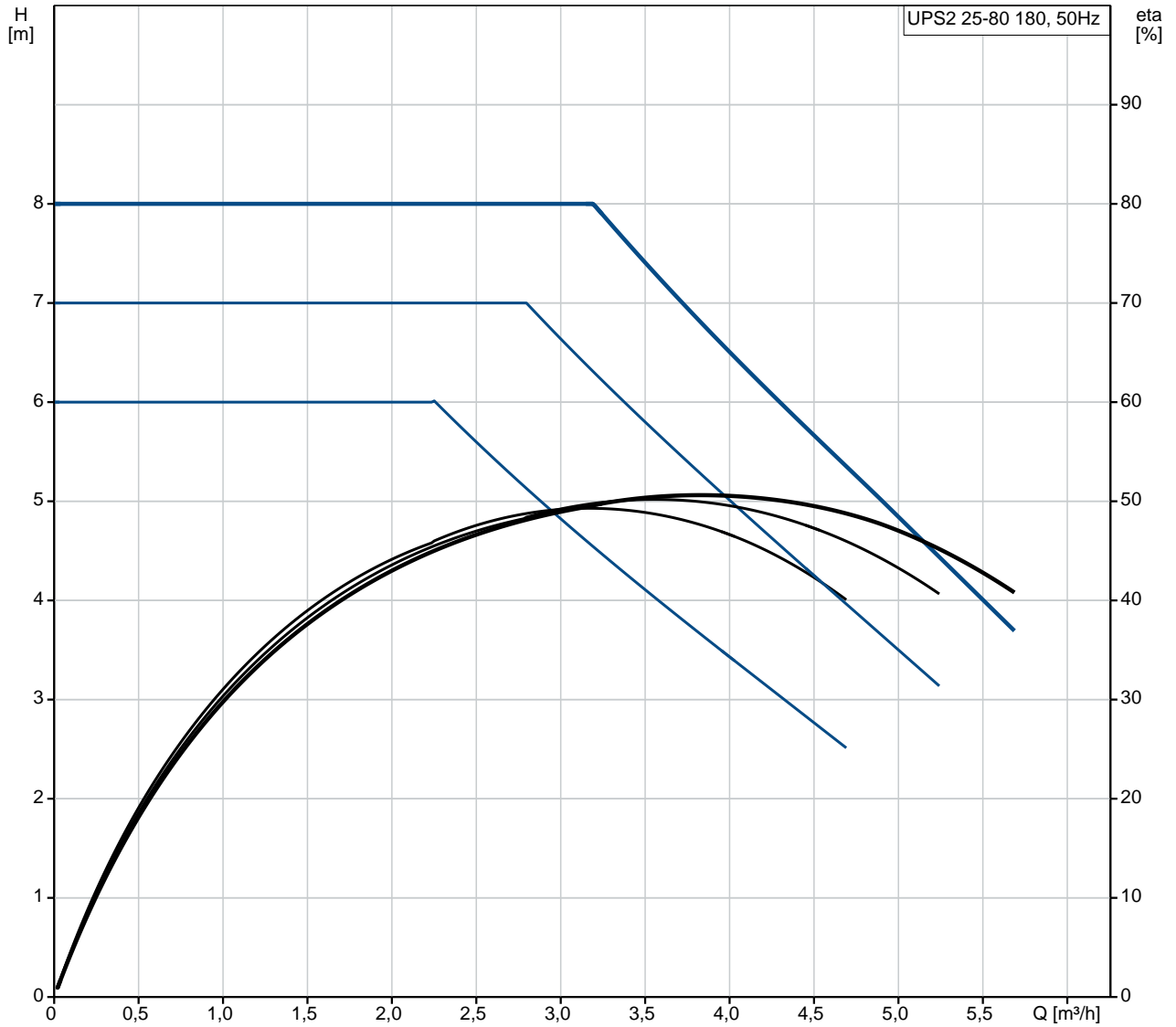

Date: 15.06.2018

Descriere	Valori i tipuri
Informa ii generale:	
Nume produs::	UPS2 25-80 180
Nr. produs::	98707853
Numărul EAN::	5712600251908
Technical:	
În l ime de pompare max.:	80 dm
Clasa TF:	95
Aprob ri pe etichet :	CE
Materials:	
Corpul pompei (stator):	Font
	EN-JL1020
	ASTM A48-25B
Rotor:	Compozit, PES/PP
Instala ie:	
Presiune de func ionare maxim :	10 bar
Racordarea pompei la instala ie:	G 1 1/2
Presiune maxim de func ionare:	PN 10
Distan a dintre porturi:	180 mm
Liquid:	
Lichide pompate:	Ap
Gama temperaturii lichidului:	2 .. 95 °C
Liquid temperature during operation:	60 °C
Densitate:	983.2 kg/m ³
Electrical data:	
Frecven a re elei electrice:	50 Hz
Tensiune nominal :	1 x 230 V
Grad de protec ie (IEC 34-5):	X2D
Clas de izolare (IEC 85):	F
Tip protec ie motor încorporat :	F R
Protec ie termic :	ELEC
Controls:	
Pozi ia cutiei de conexiuni:	9H
Others:	
Energy (EEI):	0.23
Greutate net :	2.5 kg
Greutate brut :	2.7 kg
Volum de transport:	0.005 m ³

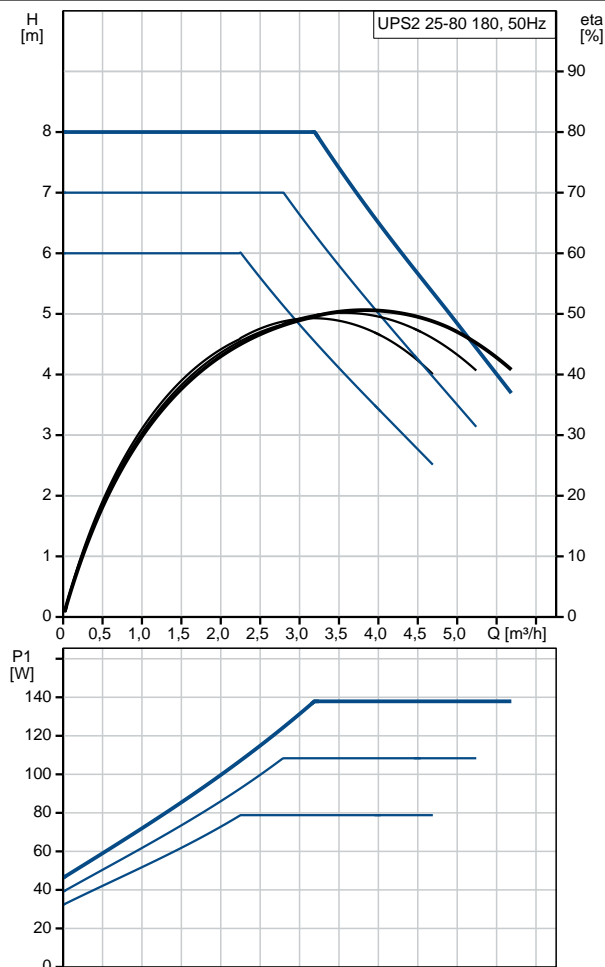

98707853 UPS2 25-80 180 50 Hz

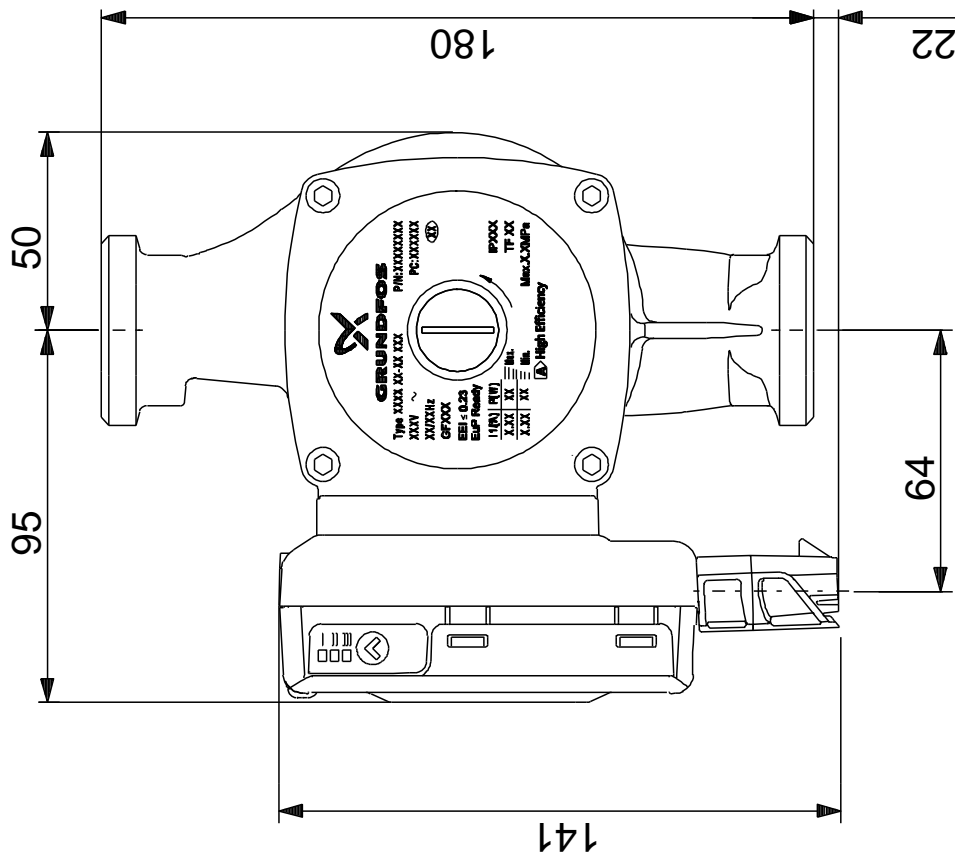
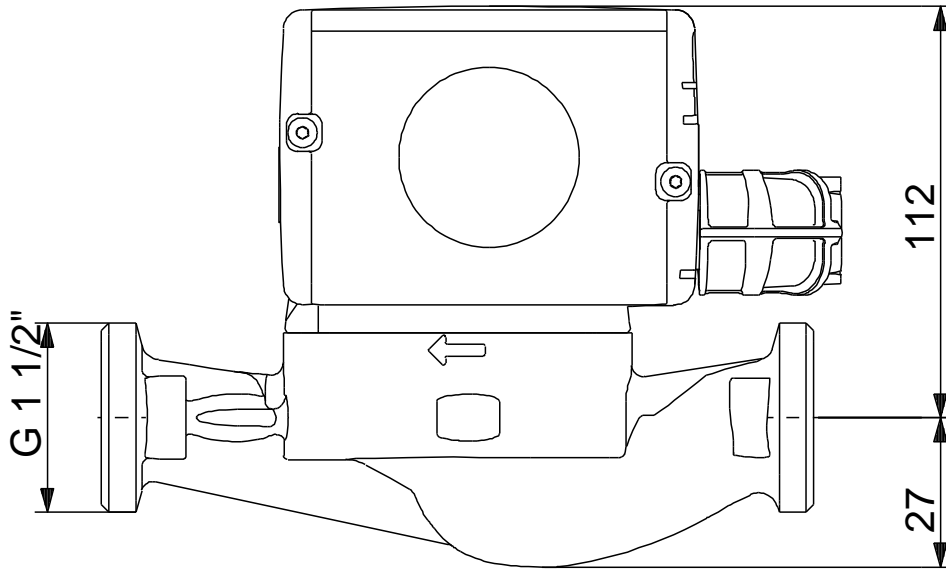

Note! All units are in [mm] unless others are stated.
Disclaimer: This simplified dimensional drawing does not show all details.

98707853 UPS2 25-80 180 50 Hz

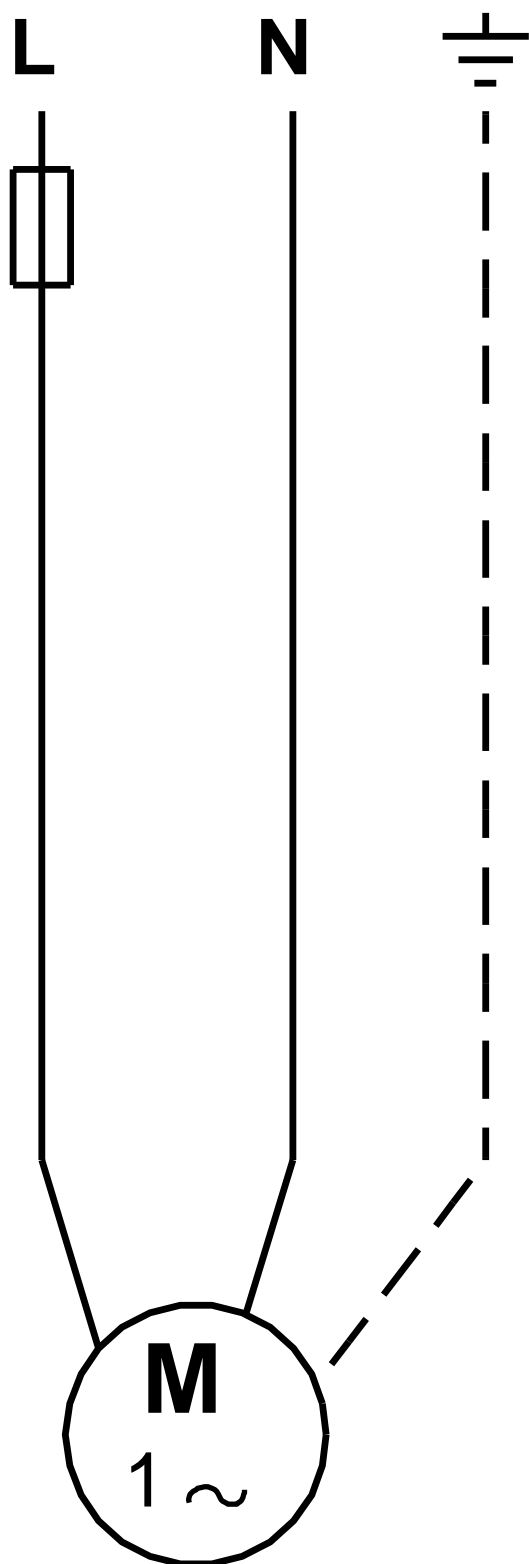

Not ! Toate unit ile sunt în [mm] dac nu altele sunt condi iile.