

ART. 750 - 751 FILTER



TECHNICAL INFO SHEET

FUNCTION

Filters 750 and 751 provide a continuous supply of filtered water. The filter retains foreign bodies which have not dissolved in the water such as rust particles, hemp strands, sand, etc.

Sediments retained in the lower part of the filter are eliminated by draining during washing, performed manually by opening the valve on the outlet.

Their compact construction and relatively small dimensions make these filters an ideal solution in residential applications for hot/cold waters.

They have a control manometer and a drain valve to wash and remove all impurities.

ART. 750



ART. 751

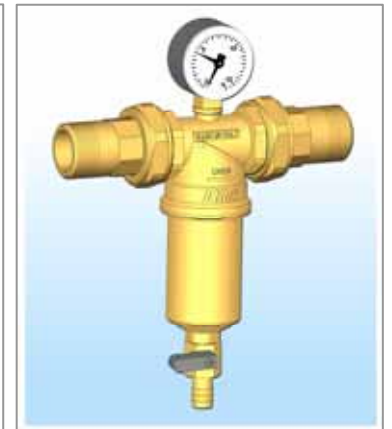

PRODUCTS

Art. 750

Code	Size	Thread
83750AD05	G 1/2"	F
83750AE05	G 3/4"	F
83750AF05	G 1"	F
83750AG05	G 1 1/4"	F
83750AH05	G 1 1/2"	F
83750AJ05	G 2"	F

Art. 751

Code	Size	Thread
83751AD05	G 1/2"	M
83751AE05	G 3/4"	M
83751AF05	G 1"	M
83751AG05	G 1 1/4"	M

TECHNICAL FEATURES

Body	Brass CW 617 N - UNI EN 12165
Unions	Brass CW 617 N - UNI EN 12165
Cup	Brass CB752S DIN50930 (with O-ring - G 1/2" - G3/4")
Fluid	water
Operating temperature	65°C
Minimum operating pressure	1.5 bars
Maximum operating pressure	25 bars
Max. working temperature	90°C
Plastic components	POM
O-ring	NBR
Filtering mesh	Stainless steel
Filtering rate	100 micron

DIMENSIONS

CODE		83750AD05	83750AE05	83750AF05	83750AG05	83750AH05	83750AJ05
INTERNAL THREAD	A	1/2"	3/4"	1"	1 1/4"	1 1/2"	2"
CONNECTION SIZE	B	3/4"	1"	1 1/4"	1 1/2"	-----	-----
DIMENSIONS	C	80	80	100	100	110	116
	D	170	170	185	185	230	230
	F	250	250	270	270	320	320

CODE		83751AD05	83751AE05	83751AF05	83751AG05
UNION SIZE	A	1/2"	3/4"	1"	1 1/4"
DIMENSIONS	C	80	80	100	100
	D	170	170	185	185
	E	130	140	170	170
	F	250	250	270	270

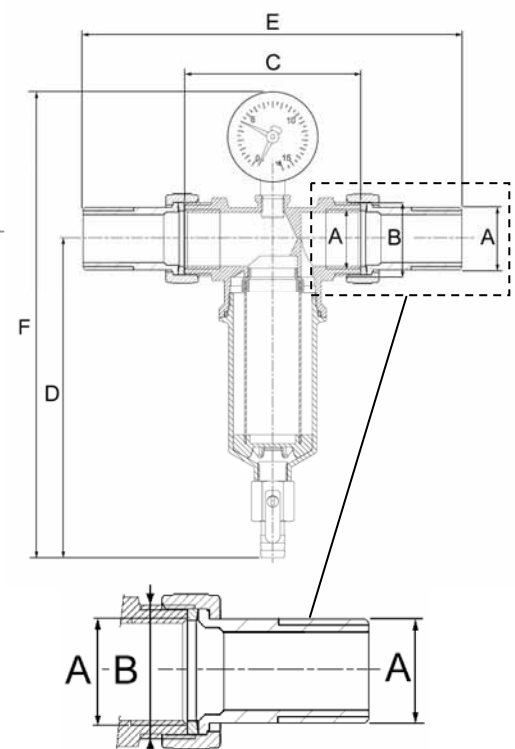

WASHING

Filters 750 and 751 have a washable body and filtering insert. During regular operation all the water flows through the filtering mesh and is directed toward utilities. If we open the cock on the ball valve (A in fig.1), washing begins: most of the water is sent to the drain outlet, washing the filter and eliminating impurities; a smaller percentage of water continues to be filtered and directed toward the outlet, ensuring a continuous supply for the utilities. Washing serves to eliminate sediments which are deposited on the bottom of the cup. The interval between washes depends on the impurities present in the water.

When the valve is closed again, the filter automatically resumes regular operation.

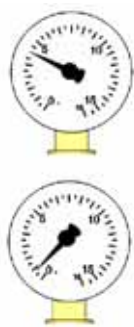

Regular operation

Possible accumulation of impurities. Wash or replace the filter element.

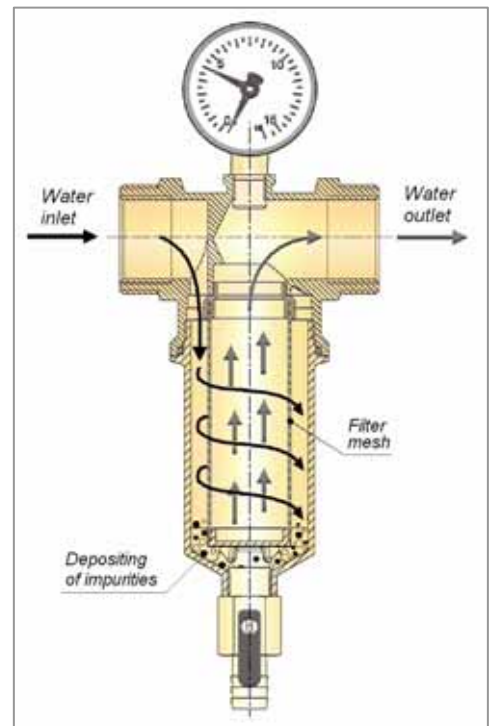
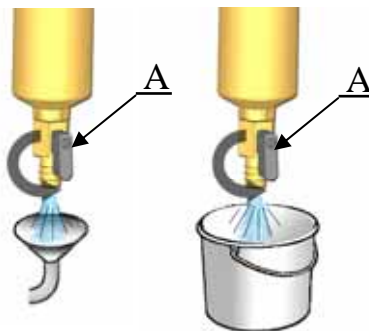

INSTALLATION AND ASSEMBLY

Filters are designed for filtering water for residential use, but may be used for other applications as well, within the specified limits.

The direction of flow of the fluid must be respected during installation.

Their reduced bulk allows these filters to be installed in small spaces, protecting devices downstream from impurities in suspension in the water.

To guarantee efficient operation, install filter 750 in a horizontal segment with the cup downward. Wash the pipe well prior to installation. Manual on/off valves may be used to ensure regular maintenance with no impact on the rest of the pipe.

Install the filter in an easily accessible place so you can read the pressure gauge and perform maintenance without difficulty. Filters must not be exposed directly to sunlight or solvent vapours.

If possible, install the filter immediately after the water meter.

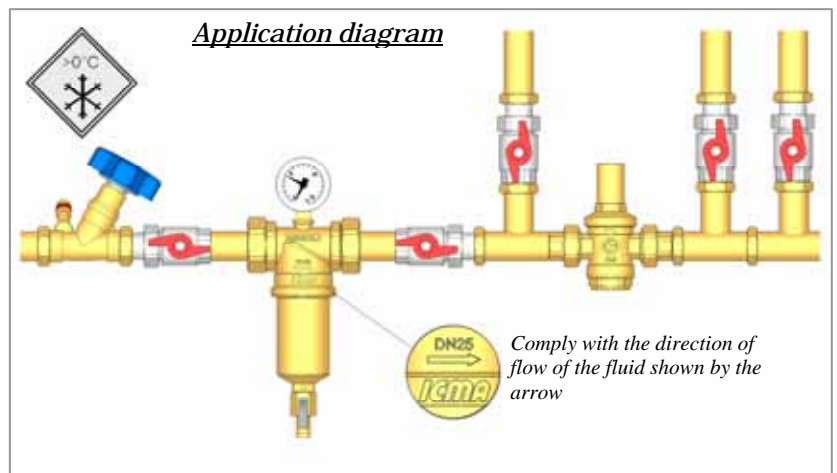

MAINTENANCE

The frequency of replacement of the filtering mesh depends on the amount of impurities in the water. Maintenance must be performed at least every 6 months to ensure hygiene. To keep internal components in good condition, do not use cleaning products containing solvents. Do not twist when assembling the cup.

REPLACING THE FILTER MESH

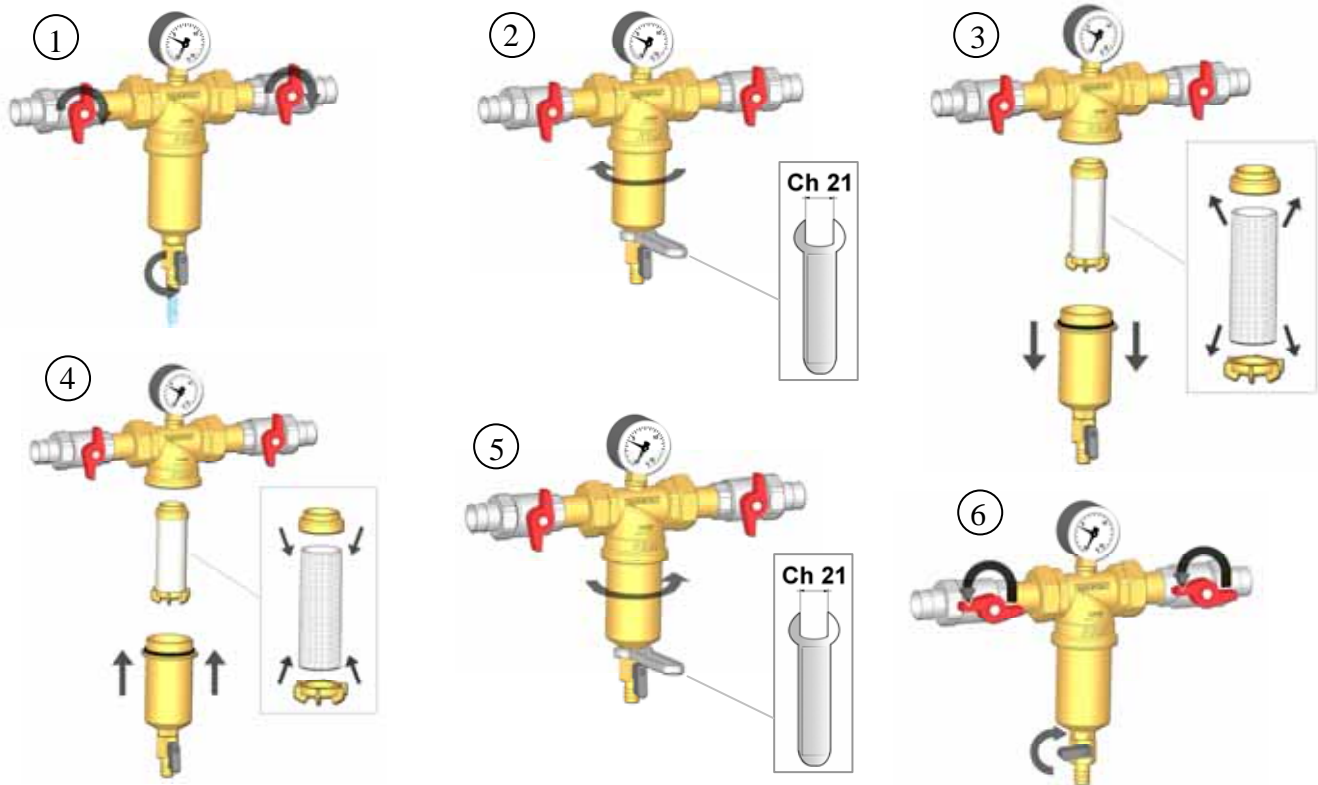

LOAD LOSS DIAGRAM

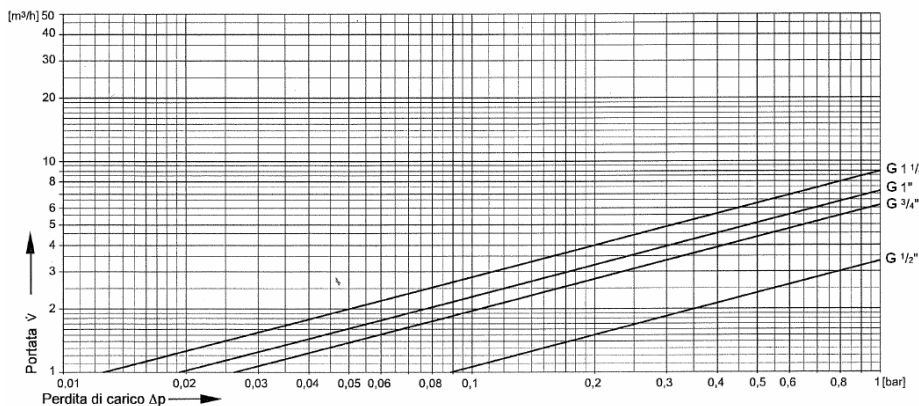

CODE	SIZE	Kvs
83750AD05	G 1/2"	3.4
83751AD05	G 1/2"	3.4
83750AE05	G 3/4"	6.5
83751AE05	G 3/4"	6.5
83750AF05	G 1"	7.1
83751AF05	G 1"	7.1
83750AG05	G 1 1/4"	8.6
83751AG05	G 1 1/4"	8.6
83750AH05	G 1 1/2"	11.5
83750AJ05	G 2"	15.9

SAFETY

Use the filter in perfect condition for its intended purpose, taking into account safety legislation and any hazards that may be present.



Read the assembly and start-up instructions and comply with them scrupulously before starting the system to prevent accidents and damage to the system caused by improper use. Remember that the guarantee will be forfeited in the event of any unauthorised changes or tampering with the device during assembly and construction. Comply with all safety warnings, and if you have any doubts about use or changes to parameters or functions, request the assistance of qualified service personnel.

Assembly and inspection operations must absolutely be performed by qualified, authorised personnel aware of the instructions contained herein. Make sure that the equipment is turned off before beginning any work on it.