



**TWO STAGE PROGRESSIVE AND MODULATING GAS BURNERS**

▶ **RIELLO 40 GS/M SERIES**

▶ **GS 10/M** 22/42 ÷ 105 kW

▶ **GS 20/M** 43/82 ÷ 194 kW



The Riello 40 GS/M series of two stage progressive or modulating gas burners, is a complete range of products developed to respond to any request of gas burners for hot air generator according to EN 1020. These new models complete the Riello 40 gas series which prides itself on many years of experience in all the world in the field of residential heating and soft industrial applications.

This series of burners is available in two different models with an output ranging from 22 to 194 kW, divided in two different structures.

Basic version of these models has two stage progressive operation. A simple modification, adding a component, permits obtaining modulating operation with a rate 1 : 4. The burners are supplied air fuel ratio control gas trains.

This more advanced version can better satisfy market needs for applications where modulation is requested to obtain highest plant efficiency.

In developing these burners, special attention was paid to the ease of installation and adjustment, to maintaining the smallest size possible and obtaining high performance for modulating operation to fit into any sort of application available on the market.

All the models are approved by the EN 676 European Standard and they conform to European Directives: Gas Appliances, EMC, Low Voltage and Boiler Efficiency.

# TECHNICAL DATA

Model		▼ GS 10/M	▼ GS 20/M
<b>Setting</b>		Modulating (with regulator and probes accessories)	
Servo-motor	type	LANDIS	
	run time	s	
Heat output	kW	22/42±105	43/82±194
	Mcal/h	18,9/36,1±90,3	37/70,5±166,84
Working temperature	°C min./max.	0 - 40	
Net calorific value G20 gas	kWh/Nm <sup>3</sup>	10	
	kcal/Nm <sup>3</sup>	8.600	
G20 gas density	kg/Nm <sup>3</sup>	0,71	
G20 gas delivery	Nm <sup>3</sup> /h	2,2/4,2±10,5	4,3/8,2±19,4
Net calorific value LPG gas	kWh/Nm <sup>3</sup>	25,8	
	kcal/Nm <sup>3</sup>	10	
LPG gas density	kg/Nm <sup>3</sup>	2,019	
LPG gas delivery	Nm <sup>3</sup> /h	0,85/1,63±4,07	1,67/3,18±7,52
Fan	type	Forward blades	
Air temperature	max °C	60	
Electrical supply	Ph/Hz/V	1/50/230 (±10%)	
Aux. electrical supply	Ph/Hz/V	--	
Control box	type	LMG 22	
Total electrical power	kW	0,130	0,250
Rated total current	A	0,8	1
Protection level	IP	X0D (IP 40)	
Motor supply	Nfasi/V/Hz	1/230/50 (±10%)	
Motor electrical power	kW	0,09	0,15
Rated motor current	A	0,7	1,3
Motor start current	A	2,8	5,2
Motor protection level	IP	20	
Aux. electrical power	kW	0,04	
Auxiliary rated current	A	0,5	
Ignition transformer		230V - 1x15 kV	
		0.2A - 25mA	
Operation		Intermittent	
Sound pressure	dB(A)	65	72
Sound output	W	--	
CO emissions	mg/kWh	30	
NOx emissions	mg/kWh	100	110
Directives		90/396/EEC, 89/336/EEC, 73/23/EEC, 92/42/EEC	
Conforming to:		EN 676	
Certifications		CE-0085BM0453	

## Reference conditions:

Temperature: 20 °C

Pressure: 1013 mbar

Altitude: 0 m a.s.l.

Noise was measured in the boiler room behind the burner at a distance of 1 meter.

Since the Company is constantly engaged in the production improvement, the aesthetic and dimensional features, the technical data, the equipment and the accessories can be changed.

This document contains confidential and proprietary information of RIELLO S.p.A. Unless authorised, this information shall not be divulged, nor duplicated in whole or in part.

# FIRING RATES

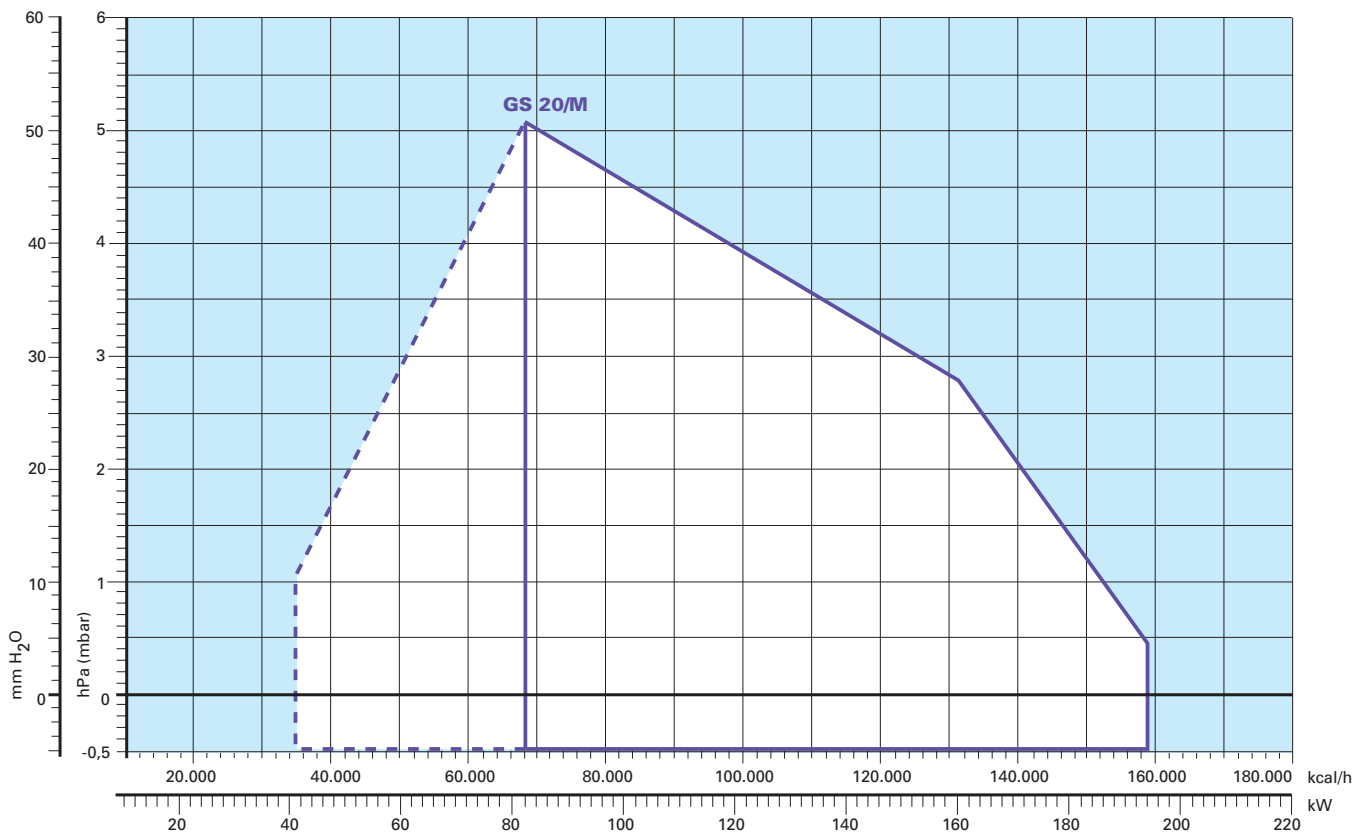
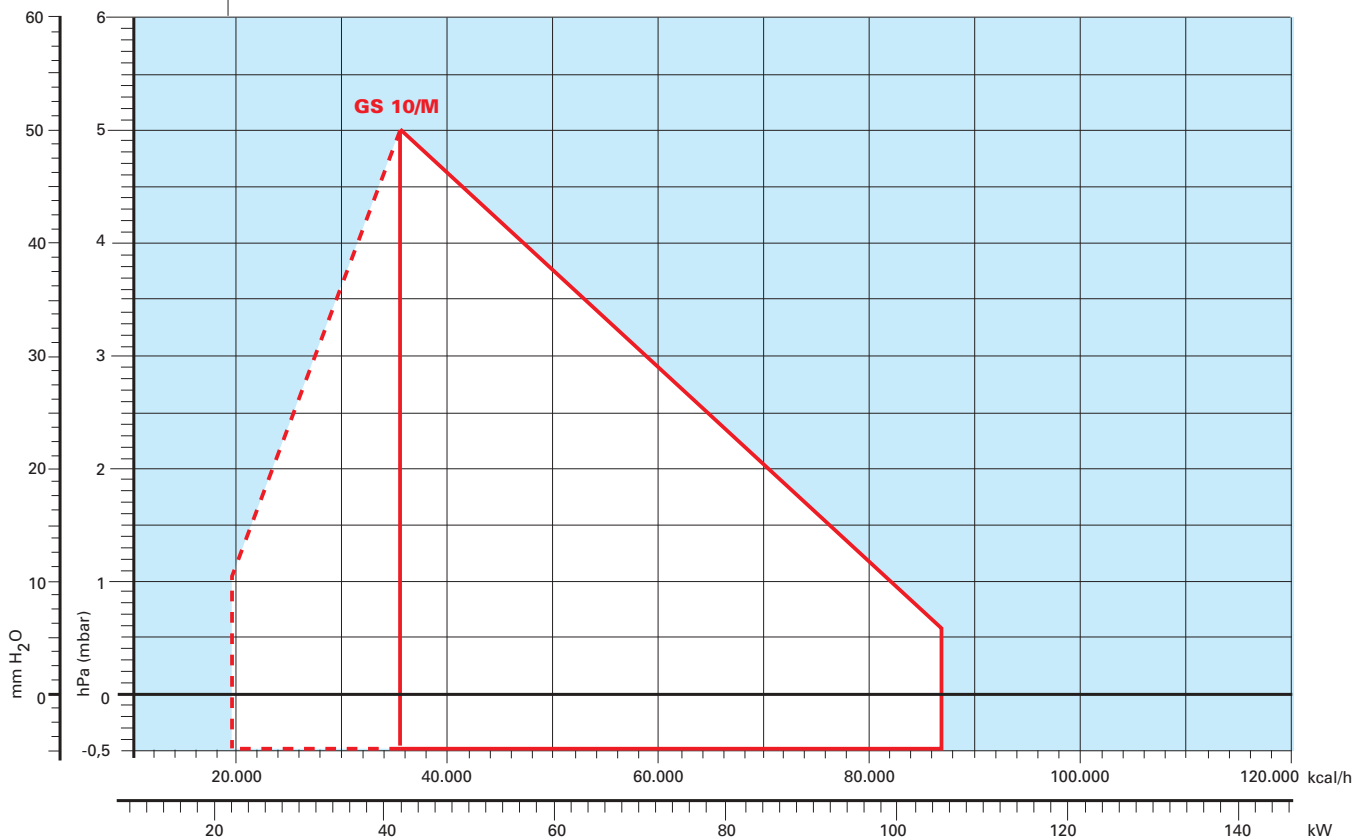

Useful working field for choosing the burner

Modulation range

**Test conditions conforming to EN 676:**

Temperature: 20 °C  
 Pressure: 1013 mbar  
 Altitude: 0 m a.s.l.





## FUEL SUPPLY

### GAS TRAIN

The burners are set for fuel supply from either the right or left hand sides.

Depending on the fuel output and the available pressure in the supply line, you should check the correct gas train to be adapted to the system requirements.

The gas train is Multibloc type, containing the main components in a single unit. A valve seal control (as accessory) can be fitted to the Multibloc gas trains.

#### MB-VEF 407-412

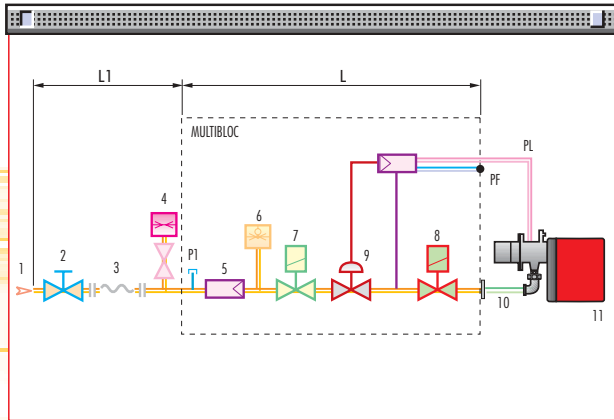

1	Gas inlet
2	Manual tip
3	Antivibrating joint
4	Gas pressure gauge
5	Gas filter
6	Min gas pressure switch
7	Safety gas valve
8	Gas valve
9	Gas regulator
10	Adapter
11	Burner
PF	Impulse line combustion chamber
PL	Impulse line combustion head
P1	Gas pressure gauge
L	Gas train to be ordered separately
L1	Supplied by the installer

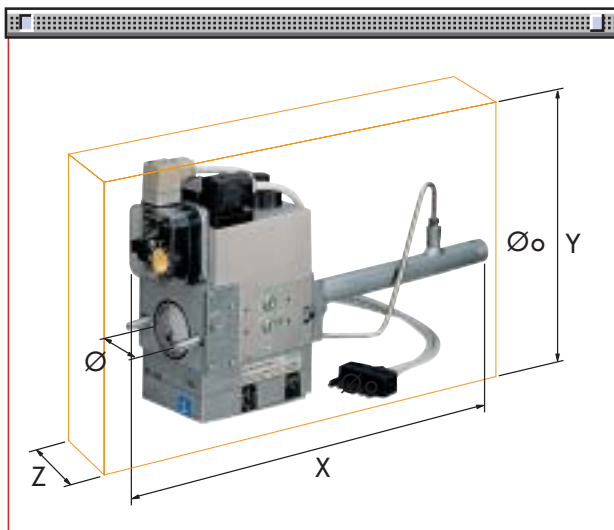

The following table shows the dimensions of the gas trains which can be fitted to Riello 40 GS/M burners, intake diameter and the coupling flange to the burner.

	Name	Code	Ø i	Øo	X mm	Y mm	Z mm
MULTIBLOC	MB-VEF 407	3970535	Rp 3/4"	Rp 3/4"	430	230	120
	MB-VEF 412	3970536	Rp 1"	Rp 3/4"	465	255	145



## ► PRESSURE DROP DIAGRAM

The diagrams indicate the minimum pressure drop of the burners with the various gas trains that can be combined with them; the value thus calculated represents the minimum required input pressure to the gas train.

### NATURAL GAS

### LPG

#### GS 10/M

#### GS 10/M

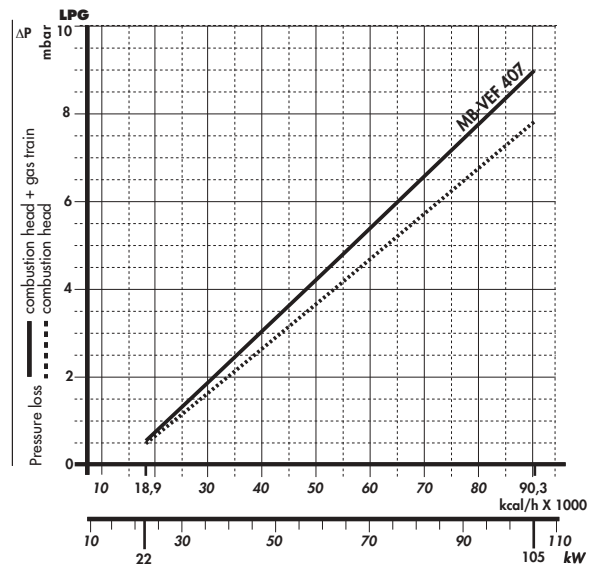
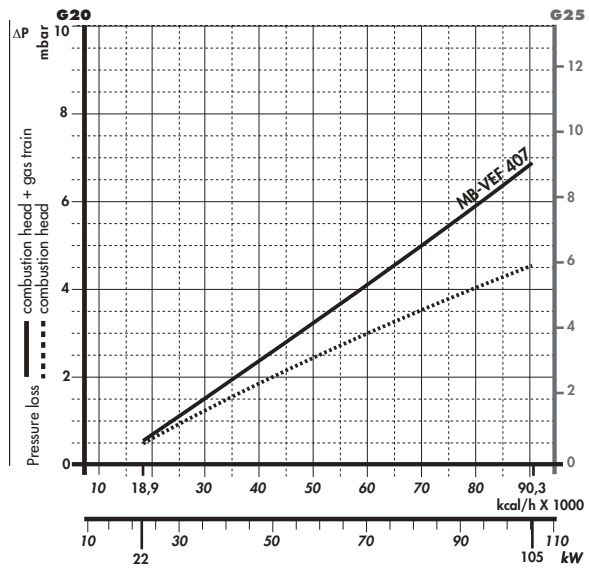

Gas train	Code
MB-VEF 407	3970535

### NATURAL GAS

### LPG

#### GS 20/M

#### GS 20/M

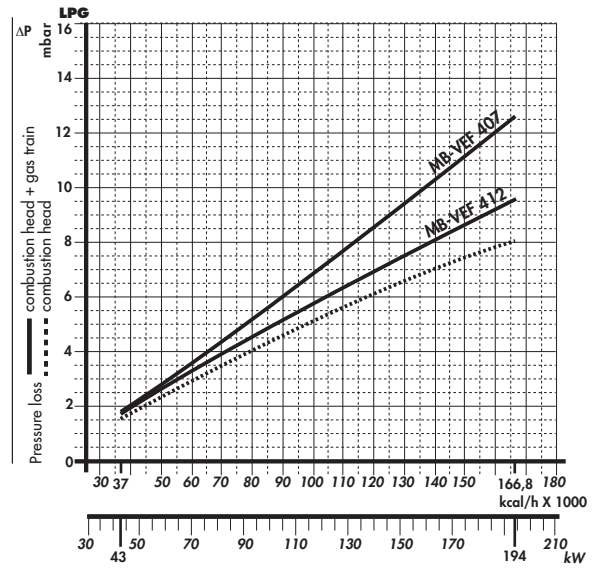
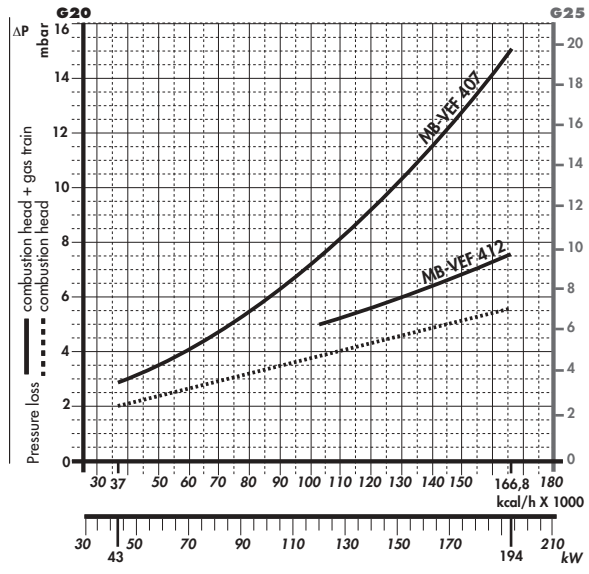

Gas train	Code	Output
MB-VEF 407	3970535	-
MB-VEF 412	3970536	≥ 120 kW*

\* With natural gas.

► **note** For pressure levels different from those indicated above, please contact Riello Burners Technical Office.





## SELECTING THE FUEL SUPPLY LINES

The following diagram enables pressure drop in a pre-existing gas line to be calculated and to select the correct gas train.

The diagram can also be used to select a new gas line when fuel output and pipe length are known. The pipe diameter is selected on the basis of the desired pressure drop. The diagram uses methane gas as reference; if another gas is used, conversion coefficient and a simple formula (on the diagram) transform the gas output to a methane equivalent (refer to figure A). Please note that the gas train dimensions must take into account the back pressure of the combustion chamber during operations.

### Control of the pressure drop in an existing gas line or selecting a new gas supply line.

The methane output equivalent is determined by the formula fig. A on the diagram and the conversion coefficient.

Once the equivalent output has been determined on the delivery scale ( $\dot{V}$ ), shown at the top of the diagram, move vertically downwards until you cross the line that represents the pipe diameter; at this point, move horizontally to the left until you meet the line that represents the pipe length.

Once this point is established you can verify, by moving vertically downwards, the pipe pressure drop of on the bottom scale below (mbar).

By subtracting this value from the pressure measured on the gas meter, the correct pressure value will be found for the choice of gas train.

**Example:**

- gas used G25
- gas output 9.51 mc/h
- pressure at the gas meter 20 mbar
- gas line length 15 m
- conversion coefficient 0.62 (see figure A)

- equivalent methane output  $\dot{V} = \left[ \frac{9.51}{0.62} \right] = 15.34 \text{ mc/h}$

- once the value of 15.34 has been identified on the output scale ( $\dot{V}$ ), moving vertically downwards you cross the line that represents 1" 1/4 (the chosen diameter for the piping);
- from this point, move horizontally to the left until you meet the line that represents the length of 15 m of the piping;
- move vertically downwards to determine a value of 1.4 mbar in the pressure drop bottom scale;
- subtract the determined pressure drop from the meter pressure, the correct pressure level will be found for the choice of gas train;

- correct pressure = ( 20-1.4 ) = 18.6 mbar

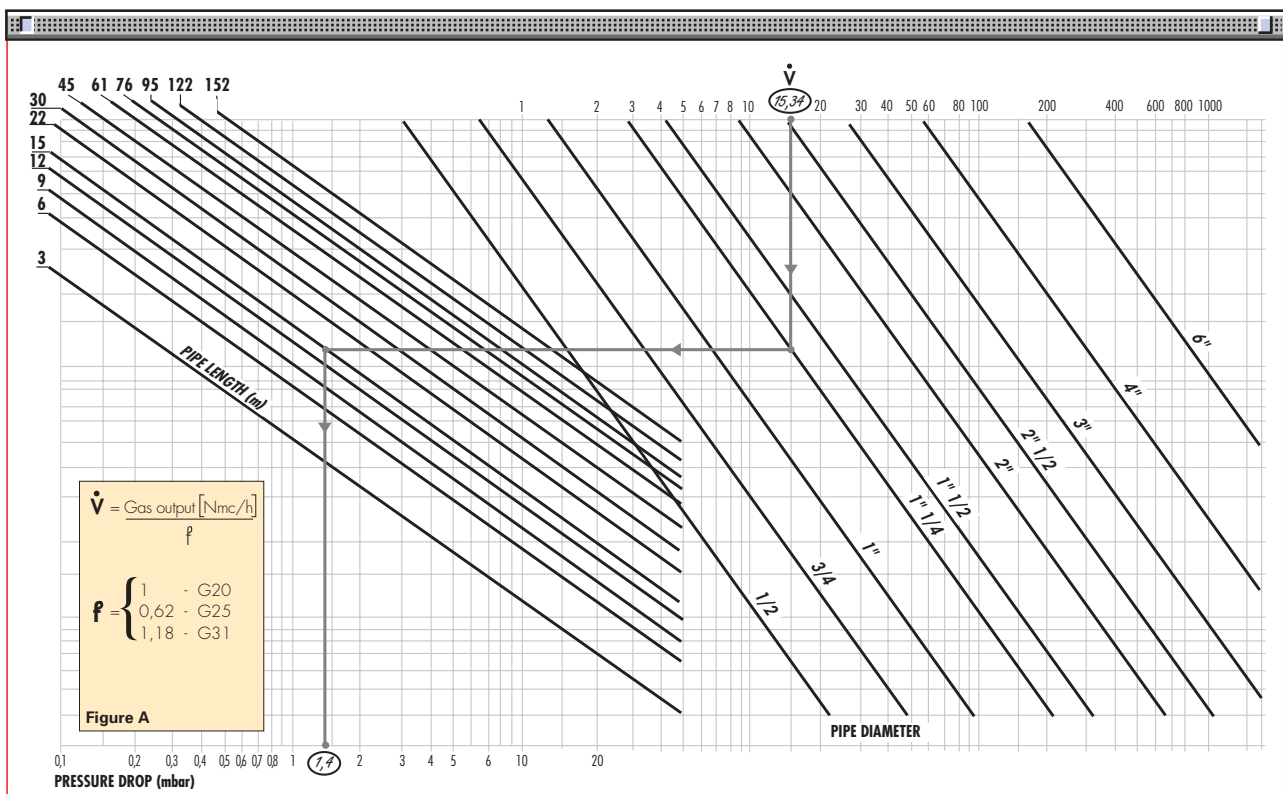

## VENTILATION

The different ventilation circuits always ensure low noise levels with high performance of pressure and air delivery, inspite of their compact size.

The burners are fitted with an adjustable air pressure switch, conforming to EN 676 standards.



Air suction

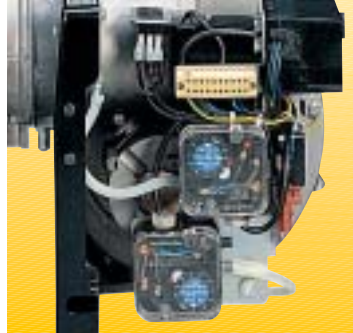

Min and max air pressure switches

## COMBUSTION HEAD

The combustion head in Riello 40 GS/M Heater burners is the result of an innovative design, which allows combustion with low polluting emissions, while being easy to adapt to all the various types of boilers and combustion chambers.



Combustion head



Flange

Simple adjustment allows the internal geometry of the combustion head to be adapted to the burner output.

### Dimensions of the flame

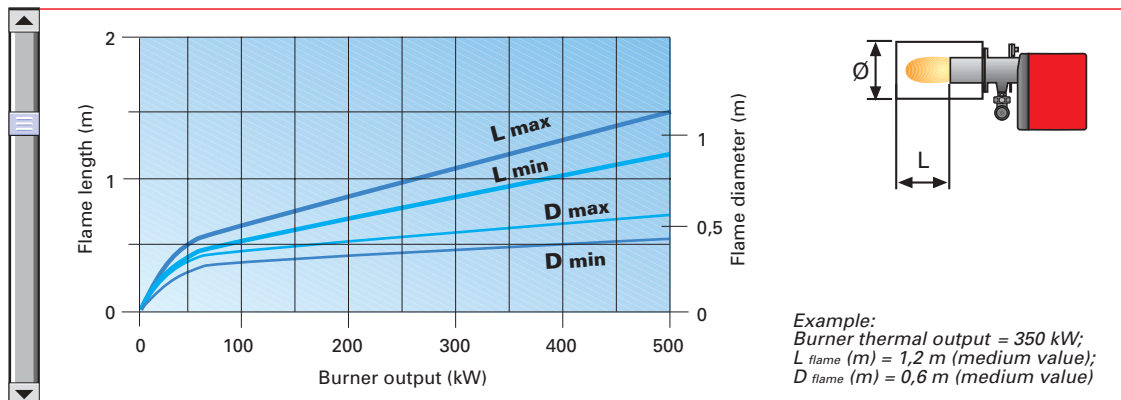

# ADJUSTMENT



## BURNER OPERATION MODE

All these models in standard version are two-stage progressive operation. Adding the output regulator device they are modulating operation.



Air damper adjustment

On "two-stage progressive" operation, the burner gradually adapts the output to the requested level, by varying between two pre-set levels (see figure A).

On "modulating" operation, normally required in steam generators, in superheater boilers or diathermic oil burners, a specific regulator and probes are required. These are supplied as accessories that must be ordered separately. The burner can work for long periods at intermediate output levels (see figure B).

### "Two-stage progressive" operation

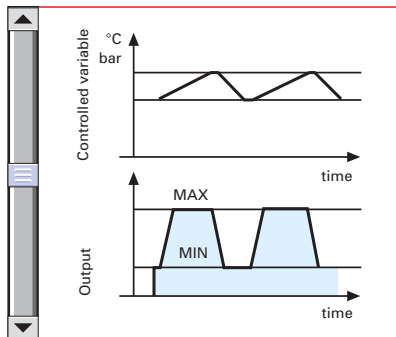

Figure A

### "Modulating" operation

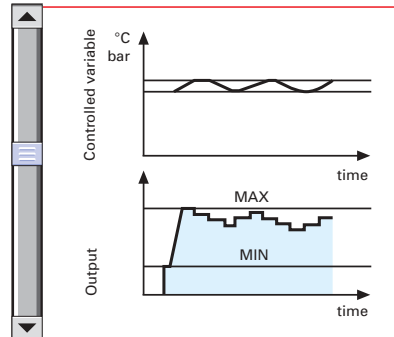
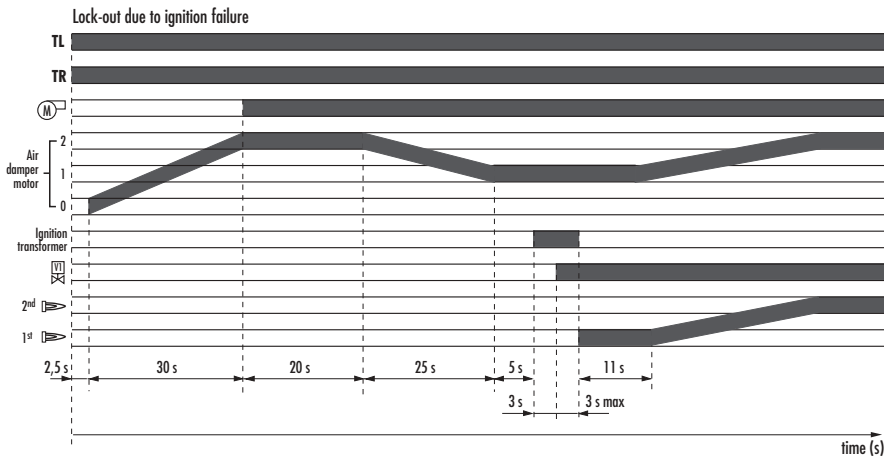

Figure B

## START UP CYCLE



### Correct operation

- 0s The burner begins the ignition cycle.
- 0s-2,5s Safety time.
- 2,5s-32,5s Progressive open of the air damper until the 2nd stage position.
- 32,5s-52,5s Pre-purge at the 2nd stage.
- 52,5s-77,5s The air damper closes until 1st stage position.
- 77,5s-82,5s Pre-purge at the 1st stage.
- 82,5s-88,5s The ignition transformer starts.
- 85,5s The solenoid opens.
- 88,5s-99,5s Ignition 1st stage.
- 99,5s Ignition 2nd stage.

If the flame does not light within the safety limit (~3s) the burner locks-out. Lock-out is shown by a led on the appliance.



# WIRING DIAGRAMS

Electrical connections must be made by qualified and skilled personnel in conformity with the local regulations in force.

The 7-pole socket is incorporated inside the burner, the 4-pole socket (for connecting the 2nd stage thermostat to the hour meter) and the 6-pole (for connection to the gas train) are already connected to the equipment and fixed to the inside of the burner.  
The 7 and 4-pin plugs are also supplied for connection to the boiler.

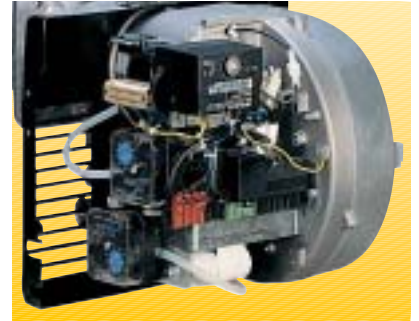

Appliance fitted with 7-pole, 6-pole and 4-pole sockets

## "TWO STAGE" PROGRESSIVE OPERATION

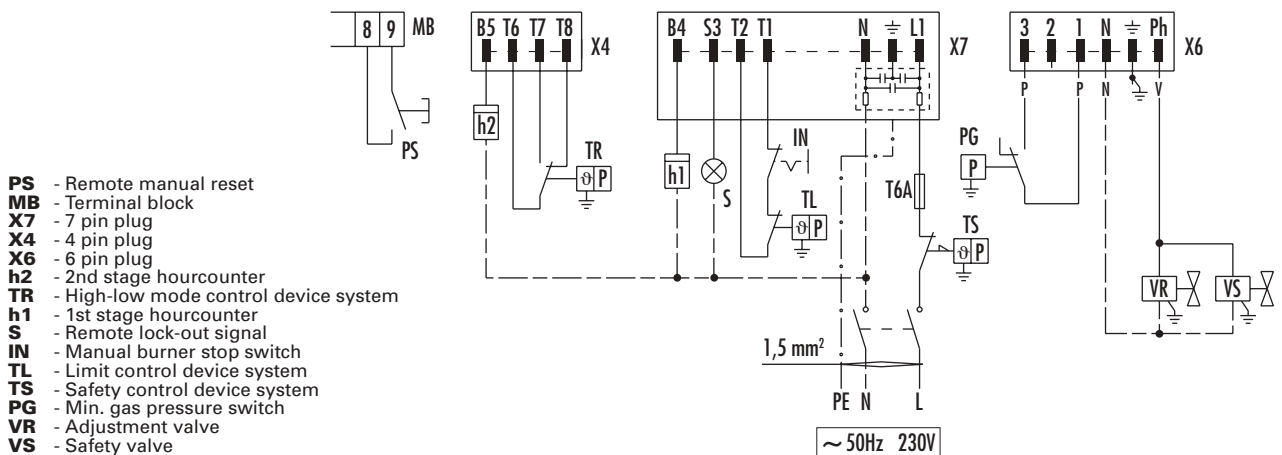

## "MODULATING" OPERATION (WITH REGULATOR)

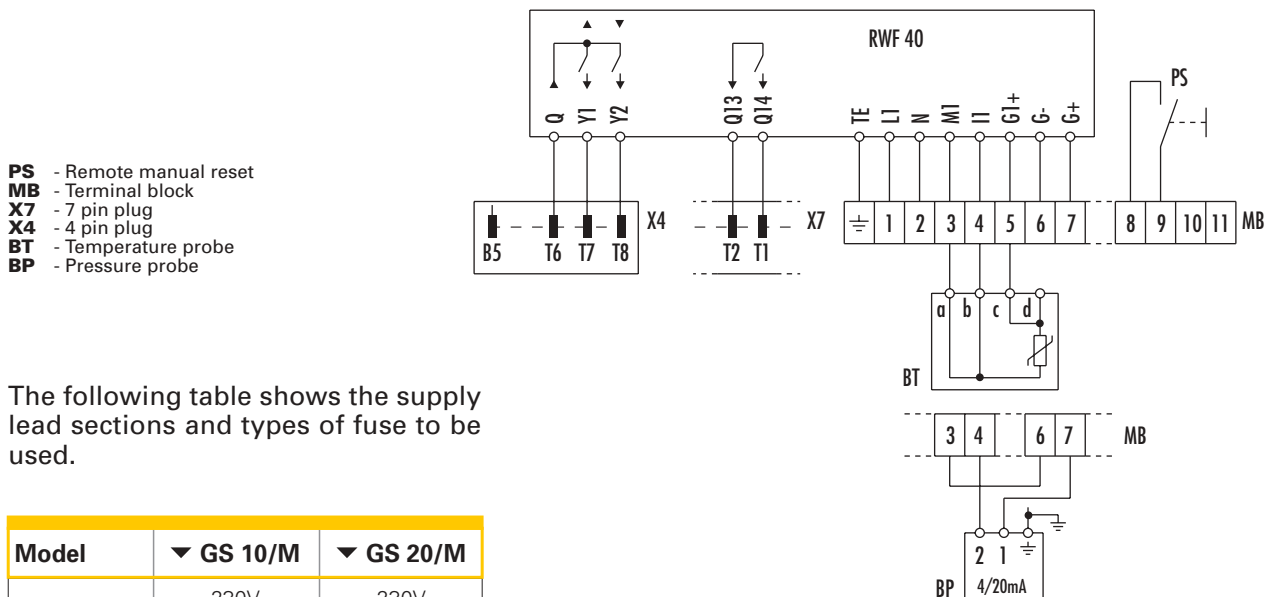

The following table shows the supply lead sections and types of fuse to be used.

Model	▼ GS 10/M	▼ GS 20/M
F	230V	230V
A	T6	T6
L	1	1

F = Fuse      L = Lead section





## EMISSIONS



The emission data have been measured in the various models at maximum output, in conformity with EN 676 standard.

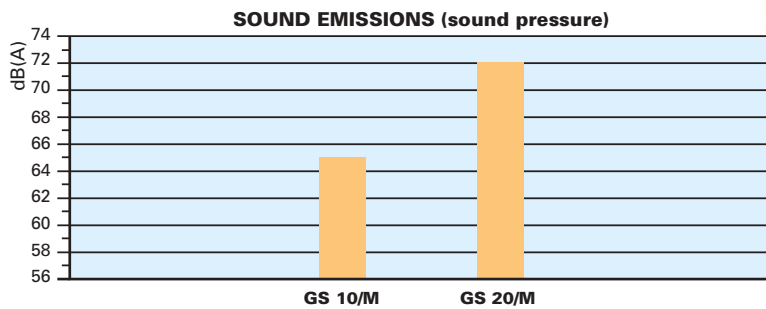
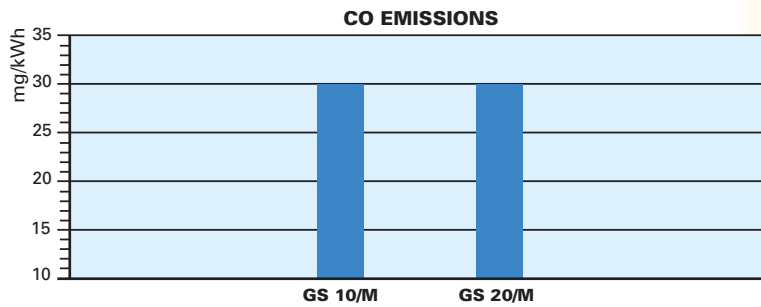
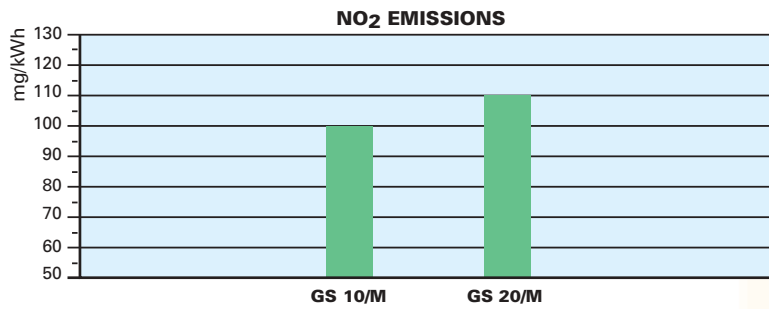

Special attention has been paid to noise reduction. All models are fitted with sound-proofing material inside the cover.



## OVERALL DIMENSIONS (mm)

These models are distinguished by their reduced size, in relation to the outputs achieved, which means they can be fitted to any boiler actually on the market.



### BURNER

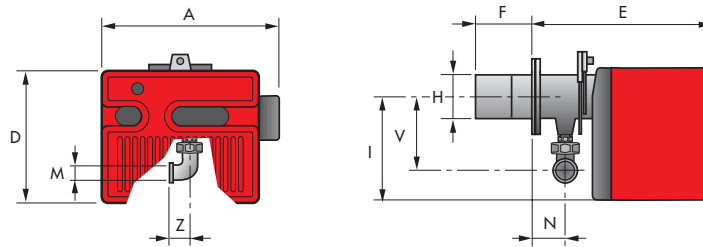

Model	A	D	E	F	H	I	M	N	V	Z
▶ GS 10/M	425	262	347	110	105	204	Rp 3/4"	61	142	33
▶ GS 20/M	488	298	389	120	125	230	Rp 3/4"	67	152	33

### BURNER-BOILER MOUNTING FLANGE

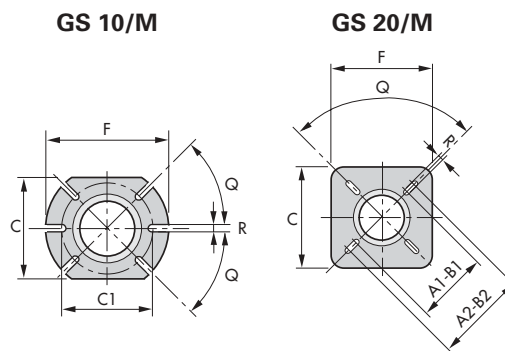

Model	A1	A2	B1	B2	C	C1	F	Q	R
▶ GS 10/M	-	-	-	-	160	130	185	45	10
▶ GS 20/M	155	200	155	200	170	-	170	90	11

### PACKAGING

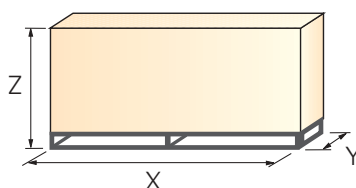

Model	X	Y	Z	kg
▶ GS 10/M	505	490	330	17
▶ GS 20/M	560	535	375	17



## INSTALLATION DESCRIPTION

Installation, start up and maintenance must be carried out by qualified and skilled personnel.

All operations must be performed as described in the technical handbook supplied with the burner.

The burner is set in the factory on standard calibration (minimum output). If necessary adjustments can be made on the basis of the maximum output of the boiler.

### BURNER SETTING

▶ The gas flow rate for both high and low capacity must be done by using the screws **V** and **N** on the gas valve group. The air flow must be adjusted at maximum output by the air damper.

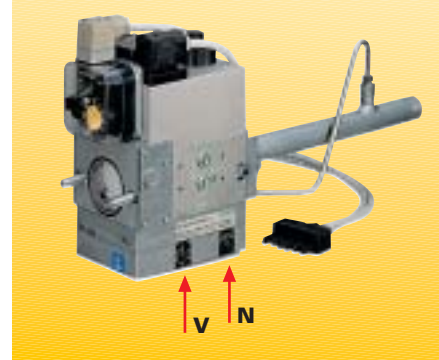

▶ If necessary it is possible to increase the minimum output by moving a cam of the air servomotor.



▶ In according to EN 676 and EN 1020, the GS 10/M and GS 20/M are provided by two air pressure switches to be adjusted at the end of commissioning procedure.

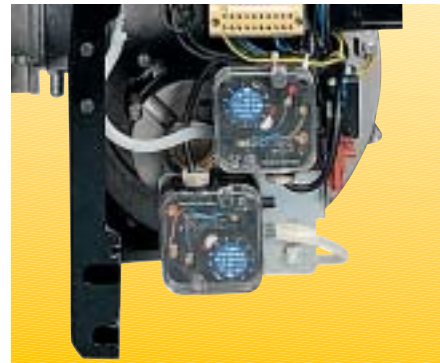

### MAINTENANCE

▶ Particular care is given to the design of the burner to ensure ease of maintenance. The burner body is hinged to permit quick and easy access to the combustion head for maintenance and setting.

To make friendly all the operations on the burner, the internal and external components are connected by plugs and sockets.

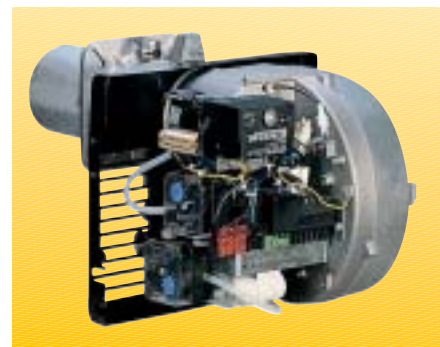

## BURNER ACCESSORIES

### LPG kit

For burning LPG gas, a special kit is available to be fitted to the combustion head on the burner, as shown in the following table:



LPG kit		
Burner	Kit code for standard head	Kit code for extended head
GS 10/M	3000884	3000884
GS 20/M	3000886	3000886



### Extended head kit

Standard head" burners can be transformed into "extended head" versions by using the special kit. Below the KITS available for the various burners are listed, showing the original and the extended lengths.

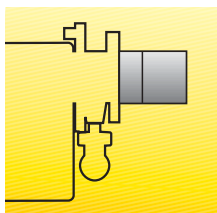

Extended head kit			
Burner	Standard head length (mm)	Extended head length (mm)	Kit code
GS 10/M	128	188	3000864
GS 20/M	120	280	3000873

### Accessories for modulating operation

To obtain modulating setting, the GS/M series of burners requires a regulator.



Regulator	
Regulator type	Regulator code
RWF 40	3001074

The relative temperature or pressure probes fitted to the regulator, must be chosen on the basis of the application.



Probe		
Probe type	Range (°C) (bar)	Probe code
Temperature PT 100	-100 ÷ 500°C	3010110
Pressure 4 ÷ 20 mA	0 ÷ 2,5 bar	3010213
Pressure 4 ÷ 20 mA	0 ÷ 16 bar	3010214

### 7-pin plug kit

If necessary a 7-pin plug kit is available (in packaging of n. 5 pieces).

7-pin plug kit	
Burner	Code
All the models	3000945



## Ground fault interrupter kit

A "Ground fault interrupter kit" is available as a safety device in case of electrical system fault. It is supplied with burners with pin plug.



Ground fault interrupter kit	
<b>Burner</b>	<b>Kit code</b>
All the models	3001180



## SPECIFICATION



A special index guides your choice of burners from the various models available in the GS/M series. Below there is a clear and detailed specification description of the product.

### DESIGNATION OF SERIES

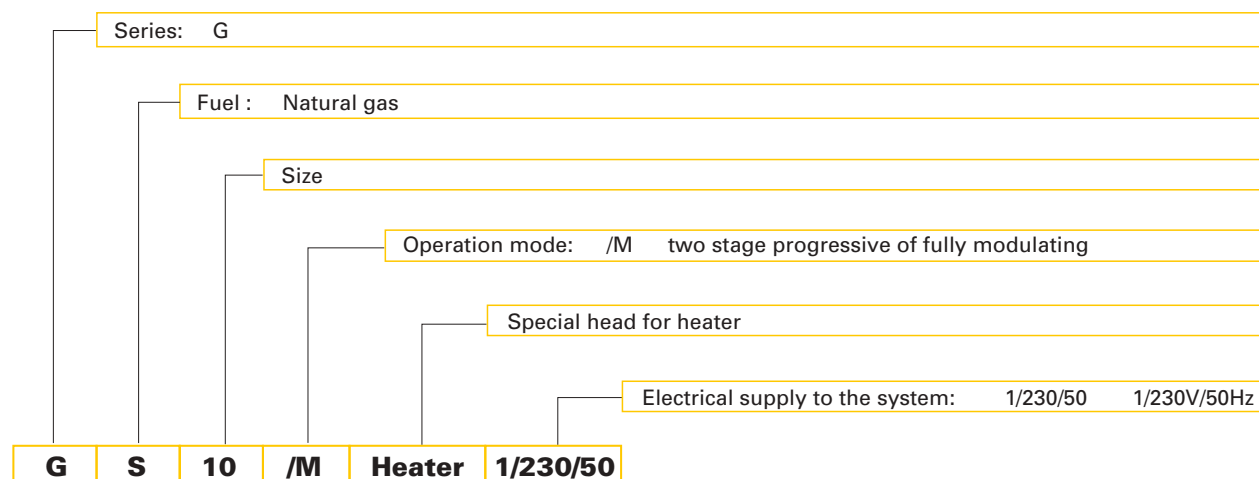

### AVAILABLE BURNER MODELS

GS 10/M Heater 22/42 ÷ 105 kW  
 GS 20/M Heater 43/82 ÷ 194 kW



## ▶ PRODUCT SPECIFICATION

### **Burner**

Monoblock, gas burners, completely automatic, high/low progressive operation mode or fully modulating by using a regulator:

- Ratio air/fuel controlled by checking both the air and the gas flows
- Two pressure switches on the burner, to make sure the burner operation, detecting both the fan and the chimney functions
- Remote reset available
- Servomotor to drive the air damper to fully closed position at stand-by, low and high fire position
- Turn down fire 1:4
- Fan with forward inclined blades
- Metallic cover
- Single phase electric motor 230 V, 50 Hz
- Combustion head fitted with:
  - stainless steel head cone, resistant to high temperatures
  - ignition electrodes
  - ionisation probe
  - gas distributor
  - flame stability disk
  - additional device, to keep short the flame shape
- Protection filter against radio interference
- IP X0D (IP 40) electric protection level.

### **Gas train**

Fuel supply line in the Multibloc configuration, fitted with:

- Filter
- Pressure stabiliser
- Minimum gas pressure switch
- Safety valve
- One stage working valve
- Self-adapting regulator, to adjust the gas flow following the air flow.

### **Approval:**

- EN 676 standard
- EN 1020 (Heaters).

### **Conforming to European Directives:**

- 90/396/EEC (gas)
- 73/23/EEC (low voltage)
- 89/336/EEC (electromagnetic compatibility)
- 92/42/EEC (efficiency).

### **Standard equipment:**

- Hinge to turn the burner left-side or right-side for the maintenance position
- Flange insulation screen
- Screws and nuts for fixing the flange to the boiler
- 7-pin plug with capacitor for EMC
- 4-pin plug to connect the high-low thermostat
- Instruction handbook for installation, use and maintenance
- Spare parts catalogue.

### **Available accessories to be ordered separately:**

- LPG kit
- RWF 40 for modulating operation
- Ground fault interrupter kit
- 7-pin plug kit
- Extended head kit.



RIELLO S.p.A. - Via degli Alpini, 1 - 37045 LEGNAGO (VR) Italy  
Tel. ++39.0442630111 - Fax ++39.044221980

Internet: <http://www.rielloburners.com> - E-mail: [rburners@rielloburners.com](mailto:rburners@rielloburners.com)

Since the Company is constantly engaged in the production improvement, the aesthetic and dimensional features, the technical data, the equipment and the accessories can be changed.  
This document contains confidential and proprietary information of RIELLO S.p.A.  
Unless authorised, this information shall not be divulged, nor duplicated in whole or in part.

