

# DeltaSol<sup>®</sup> AX

**RESOL<sup>®</sup>**

## **Differential temperature controller**

Manual for the specialised craftsman

### **Installation**

### **Operation**

### **Functions and options**

### **Troubleshooting**



48000250

Thank you for buying this RESOL product.  
Please read this manual carefully to get the best performance from this unit.  
Please keep this manual safe.

en

Manual

[www.resol.com](http://www.resol.com)

## Safety advice

Please pay attention to the following safety advice in order to avoid danger and damage to people and property.

## Instructions

Attention must be paid to the valid local standards, regulations and directives!

## Information about the product

### Proper usage

The differential temperature controller is designed for electronically controlling solar thermal, heating and air conditioning systems in compliance with the technical data specified in this manual.

Improper use excludes all liability claims.

### CE Declaration of conformity

The product complies with the relevant directives and is therefore labelled with the CE mark. The Declaration of Conformity is available upon request, please contact the manufacturer.



#### Note

Strong electromagnetic fields can impair the function of the device.

→ Make sure the device as well as the system are not exposed to strong electromagnetic fields.

**Subject to technical change. Errors excepted.**

## Target group

These instructions are exclusively addressed to authorised skilled personnel.

Only qualified electricians should carry out electrical works.

Initial installation must be effected by the system owner or qualified personnel named by the system owner.

## Description of symbols

**WARNING!** Warnings are indicated with a warning triangle!



→ **They contain information on how to avoid the danger described.**

Signal words describe the danger that may occur, when it is not avoided.

- **WARNING** means that injury, possibly life-threatening injury, can occur.
- **ATTENTION** means that damage to the appliance can occur.



#### Note

Notes are indicated with an information symbol.



#### Cross reference

A book symbol indicates a cross reference to another chapter.

→ Arrows indicate instruction steps that should be carried out.

## Disposal

- Dispose of the packaging in an environmentally sound manner.
- Dispose of old appliances in an environmentally sound manner. Upon request we will take back your old appliances bought from us and guarantee an environmentally sound disposal of the devices.

The *DeltaSol*® AX controller is the simplest solution for all differential controls. It is equipped with an adjustable temperature difference and an antifreeze function which can be activated / deactivated by DIP switches.

Furthermore it is equipped with an adjustable target temperature for minimum or maximum temperature limitation (adjustable by DIP switch). The enclosed silicone sealing cord guarantees a protection against dripping water.

## Contents

<b>1</b>	<b>Overview</b> .....	<b>4</b>
<b>2</b>	<b>Installation</b> .....	<b>4</b>
2.1	Mounting .....	4
2.2	Electrical connection .....	6
<b>3</b>	<b>Operation and function</b> .....	<b>6</b>
3.1	Flashing codes .....	6
3.2	DIP switches and potentiometres .....	6
3.3	Switch-on temperature difference.....	7
3.4	Manual mode .....	7
3.5	Maximum temperature limitation.....	7
3.6	Antifreeze function .....	7
3.7	Minimum temperature limitation.....	8
<b>4</b>	<b>Examples</b> .....	<b>8</b>
4.1	Standard solar system with 1 store .....	8
4.2	Heating circuit return preheating.....	9
4.3	Heat exchange control.....	9
4.4	Store loading by means of a solid fuel boiler .....	10
<b>5</b>	<b>Accessories</b> .....	<b>10</b>
<b>6</b>	<b>Troubleshooting</b> .....	<b>10</b>



## 1 Overview

- **Adjustable temperature difference 2 ... 16 K, hysteresis 1.6 K**
- **Antifreeze function adjustable by DIP switch**
- **Maximum or minimum temperature limitations adjustable by DIP switch**
- **Protection against dripping water**

### Technical data

**Inputs:** 2 Pt1000 temperature sensors

**Outputs:** 1 electromechanical relay (changeover)

**Switching capacity:** 4 (1) A 240 V~ (electromechanical relay)

**Total switching capacity:** 4 A 240 V~

**Power supply:** 220 ... 240 V~ (50 ... 60 Hz)

**Supply connection:** type Y attachment

**Standby:** 1.36 W

**Mode of operation:** Type 1.B

**Rated impulse voltage:** 2.5 kV

**Functions:** antifreeze function, maximum or minimum temperature limitation

**Housing:** plastic, PC-ABS and PMMA

**Mounting:** wall mounting

**Indication / Display:** 1 operating control LED

**Operation:** 2 potentiometers, 4 DIP switches

**Protection type:** IP 20 / DIN EN 60529 (with seal IP 22)

**Protection class:** II

**Ambient temperature:** 0 ... 40 °C

**Degree of pollution:** 2

**Dimensions:** Ø 139 mm, depth 45 mm

## 2 Installation

### 2.1 Mounting

#### **WARNING!** Electric shock!



Upon opening the housing, live parts are exposed!

→ **Always disconnect the controller from power supply before opening the housing!**



#### **Note**

Strong electromagnetic fields can impair the function of the device.

→ Make sure the device as well as the system are not exposed to strong electromagnetic fields.

The unit must only be located in dry interior rooms.

The controller must additionally be supplied from a double pole switch with contact gap of at least 3 mm.

Please pay attention to separate routing of sensor cables and mains cables.

In order to mount the device to a wall, carry out the following steps:

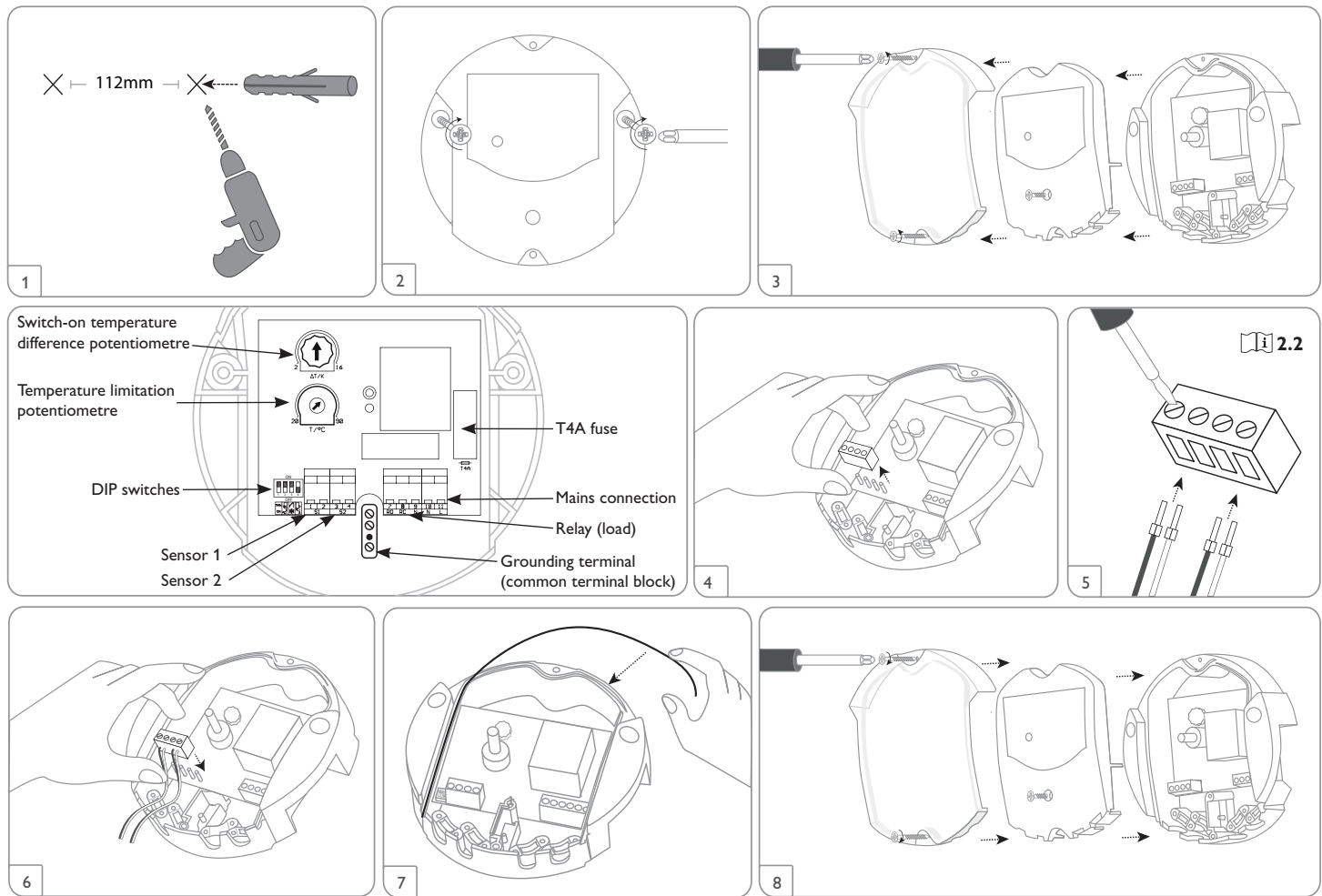

## 2.2 Electrical connection

### WARNING! Electric shock!



Upon opening the housing, live parts are exposed!

→ **Always disconnect the device from power supply before opening the housing!**

### ATTENTION! ESD damage!



Electrostatic discharge can lead to damage to electronic components!

→ **Take care to discharge properly before touching the inside of the device! To do so, touch a grounded surface such as a radiator or tap!**



### Note

Connecting the device to the power supply must always be the last step of the installation!

The controller is supplied with power via a mains cable. The power supply of the device must be 220... 240 V~ (50... 60 Hz).

The controller is equipped with 1 electromechanical relay to which a load such as a pump, a valve, etc. can be connected

- Relay 1
  - 7 = normally open contact
  - 8 = normally closed contact
  - 9 = neutral conductor (N)
  - Grounding terminal ÷ (**common terminal block**)
- Connect the **temperature sensors** (S1 and S2) to the corresponding terminals with either polarity:
  - 1/2 = Sensor 1 (e.g. collector sensor)
  - 3/4 = Sensor 2 (e.g. store sensor)
- The **mains connection** is at the terminals:
  - 10 = neutral conductor (N)
  - 11 = conductor (L)
  - Grounding terminal ÷ (**common terminal block**)

## 3 Operation and function

### 3.1 Flashing codes

The operating control lamp indicates the current status of the controller.

Colour	Permanent	Flashing
Green	Normal operation, relay active	Manual mode active, antifreeze function active
Red	Ready for operation	Store maximum temperature exceeded, temperature has fallen below minimum value

### 3.2 DIP switches and potentiometres

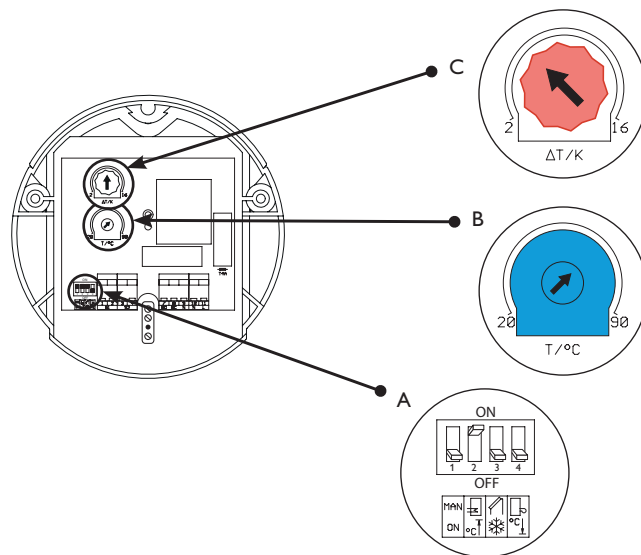

The DIP switches (A) can be used for activating (ON) or deactivating (OFF) the following functions:

- Manual mode (DIP switch 1)
- Maximum temperature limitation (DIP switch 2)
- Antifreeze function (DIP switch 3)
- Minimum temperature limitation (DIP switch 4)

With the lower potentiometer (B), the temperature for the maximum or minimum temperature limitation can be adjusted (in °C).

With the upper potentiometer (C), the switch-on temperature difference can be adjusted (in K).

### 3.3 Switch-on temperature difference

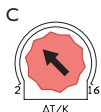

Adjustment range: 2 ... 16 K  
Factory setting: 6 K

The controller calculates the temperature difference between the temperature sensors S1 and S2. If the difference is larger than or identical to the switch-on value adjusted with the potentiometer C, the relay will be switched on. The operating control LED is green. If the temperature difference falls below the set value by 1.6 K (non-adjustable hysteresis), the controller deactivates the relay. The operating control LED is red.

### 3.4 Manual mode



Deactivated by default  
(DIP switch in OFF position)  
Controller in automatic mode

For commissioning or maintenance work, the relay can be permanently energised by means of the manual mode. The manual mode can be activated or deactivated respectively with DIP switch 1. If the manual mode is active, the operating control lamp flashes green.

### 3.5 Maximum temperature limitation

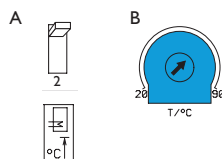

Activated by default  
(DIP switch in ON position)  
Adjustment range: 20 ... 90 °C  
Factory setting: 60 °C

With DIP switch 2, the temperature limitation can be activated as a maximum temperature limitation. The limit temperature can be adjusted by means of the potentiometer B. The sensor connected to the terminals S2 is used as the reference sensor. If the store temperature reaches the adjusted maximum temperature, the store will no longer be loaded in order to avoid damage caused by overheating. If the store temperature exceeds the maximum value, the operating control lamp is red.

### 3.6 Antifreeze function



Deactivated by default  
(DIP switch in OFF position)

With DIP switch 3, the antifreeze function can be activated. The antifreeze function activates the loading circuit between the collector and the store when the collector temperature falls below +4 °C. This will protect the fluid against freezing or coagulating. If the temperature at S1 reaches +5 °C, the pump will be switched off. When the antifreeze function is active, the operating control lamp flashes green.



#### Note

Since this function uses the limited heat quantity of the store, the antifreeze function should be used in regions with few days of temperatures around the freezing point.

### 3.7 Minimum temperature limitation

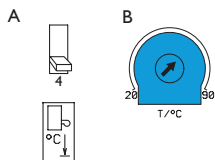

Deactivated by default (DIP switch in OFF position), default setting upon activation: 60°C

With DIP switch 4, the temperature limitation can be activated as a minimum temperature limitation. The limit temperature can be adjusted by means of the potentiometer B. The sensor connected to the terminals S1 is used as the reference sensor. The minimum collector temperature is the minimum switch-on temperature which must be exceeded for the solar pump (R1) to switch on. If the collector temperature falls below the adjusted minimum temperature, the operating control LED flashes red.

## 4 Examples

### 4.1 Standard solar system with 1 store

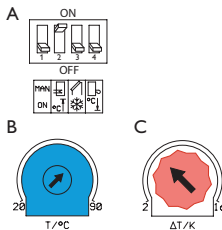

The controller calculates the temperature difference between collector sensor S1 and store sensor S2. If the difference is larger than or identical to the adjusted switch-on temperature difference, the pump (R1) will be switched on and the store will be loaded. If the temperature difference falls by 1.6K (non-adjustable hysteresis) below the adjusted temperature difference, the pump will be switched off.

S1 = Collector sensor  
S2 = Store sensor  
RO = Solar pump

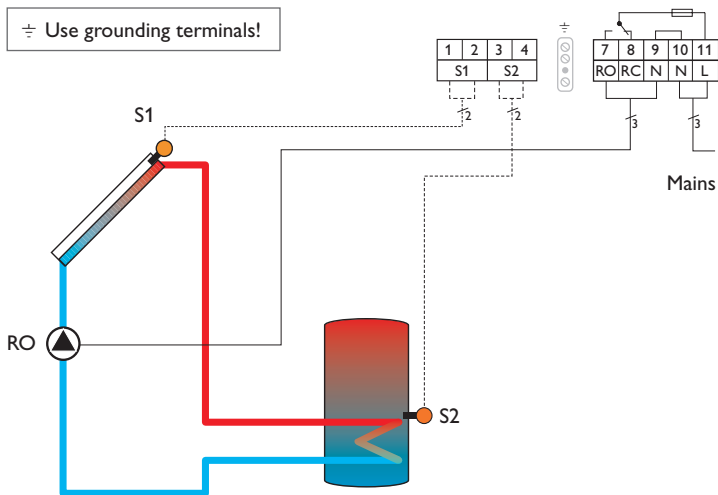

## 4.2 Heating circuit return preheating

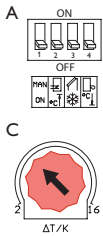

The controller calculates the temperature difference between collector sensor S1 and store sensor S2. If the difference is larger than or identical to the adjusted switch-on value, the controller switches the 3-port valve. The heat of the store is used for increasing the return temperature of the heating circuit. If the temperature difference falls by 1.6K (non-adjustable hysteresis) below the adjusted temperature difference, the valve will be put into its initial position.

- S1 = Store sensor
- S2 = Heating circuit return sensor
- RO = 3-port valve

## 4.3 Heat exchange control

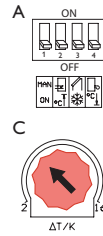

When the temperature difference between sensor 1 (store 1) and sensor 2 (store 2) exceeds the adjusted value, the circulating pump will be activated. Heat will be transferred from store 1 into store 2. If the temperature difference falls by 1.6K (non-adjustable hysteresis) below the adjusted temperature difference, the pump will be switched off.

- S1 = Sensor store 1
- S2 = Sensor store 2
- RO = Circulating pump

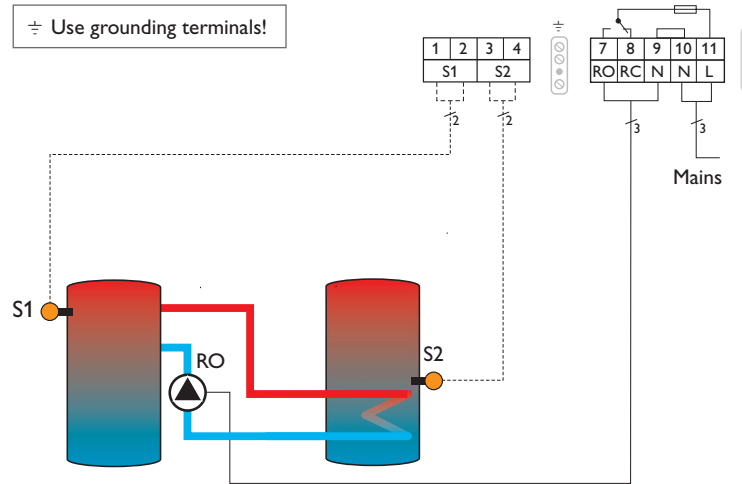
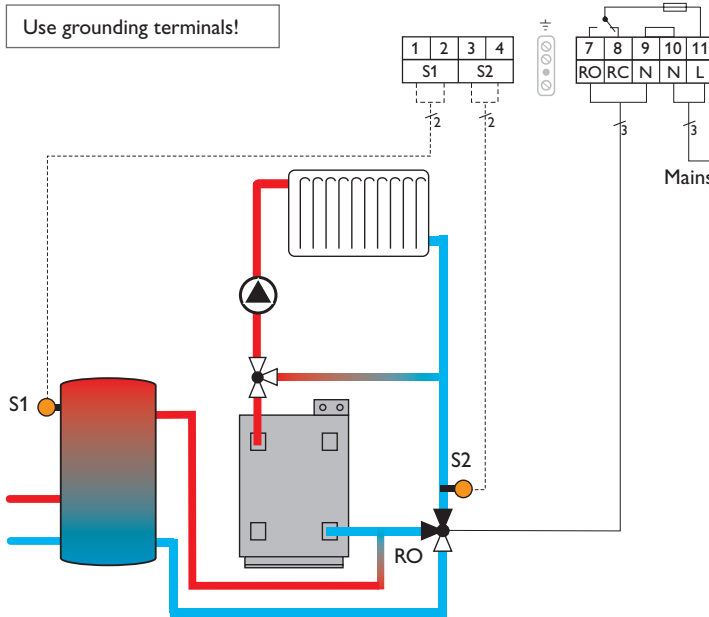

#### 4.4 Store loading by means of a solid fuel boiler

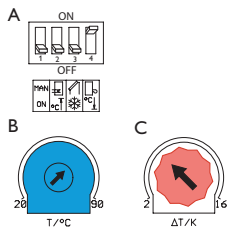

The controller calculates the temperature difference between solid fuel boiler sensor S1 and store sensor S2. The relay (RO) is energised when both switch-on conditions are fulfilled:

- the temperature difference has exceeded the switch-on value
- the temperature at the solid fuel boiler sensor has exceeded the minimum temperature

If the temperature difference falls by 1.6 K (non-adjustable hysteresis) below the adjusted temperature difference, the pump will be switched off.

S1 = Solid fuel boiler sensor

S2 = Store sensor

RO = Circulating pump

Use grounding terminals!

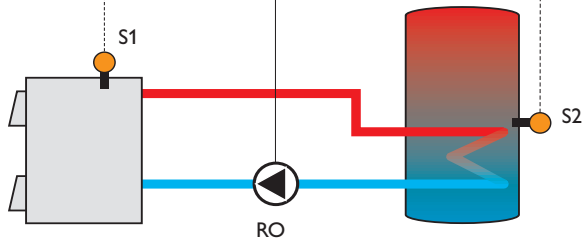
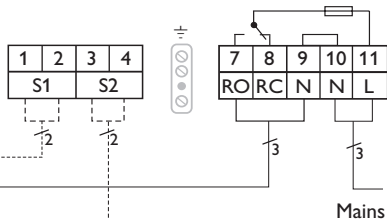

#### 5 Accessories



SP10 Overvoltage protection device



HR230 Auxiliary relay

#### 6 Troubleshooting



Spare fuse (inside the cover)

In the case of an error, please check the following:

Check the power supply of the controller. Is it disconnected?

no

yes

The fuse of the controller could be blown. The fuse holder (which holds the spare fuse) becomes accessible when the cover is removed. The fuse can then be replaced.

Check the supply line and reconnect it.

Disconnected temperature sensors can be checked with an ohmmeter. Please check if the resistance values correspond with the table.

°C	°F	Ω Pt1000	°C	°F	Ω Pt1000
-10	14	961	55	131	1213
-5	23	980	60	140	1232
0	32	1000	65	149	1252
5	41	1019	70	158	1271
10	50	1039	75	167	1290
15	59	1058	80	176	1309
20	68	1078	85	185	1328
25	77	1097	90	194	1347
30	86	1117	95	203	1366
35	95	1136	100	212	1385
40	104	1155	105	221	1404
45	113	1175	110	230	1423
50	122	1194	115	239	1442



**Note:**

For answers to frequently asked questions (FAQ) see [www.resol.com](http://www.resol.com).

Distributed by:

**RESOL – Elektronische Regelungen GmbH**

Heiskampstraße 10

45527 Hattingen / Germany

Tel.: +49 (0) 23 24 / 96 48 - 0

Fax: +49 (0) 23 24 / 96 48 - 755

[www.resol.com](http://www.resol.com)

[info@resol.com](mailto:info@resol.com)

**Important note**

The texts and drawings in this manual are correct to the best of our knowledge. As faults can never be excluded, please note:

Your own calculations and plans, under consideration of the current standards and directions should only be basis for your projects. We do not offer a guarantee for the completeness of the drawings and texts of this manual - they only represent some examples. They can only be used at your own risk. No liability is assumed for incorrect, incomplete or false information and / or the resulting damages.

**Note**

The design and the specifications can be changed without notice.

The illustrations may differ from the original product.

**Imprint**

This mounting- and operation manual including all parts is copyrighted. Another use outside the copyright requires the approval of RESOL – Elektronische Regelungen GmbH. This especially applies for copies, translations, micro films and the storage into electronic systems.